

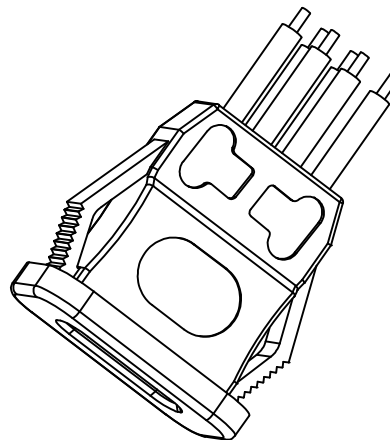

REV	DESCRIPTION	DATE	APPROVED
A	新版发行	2020.11.06	HHM

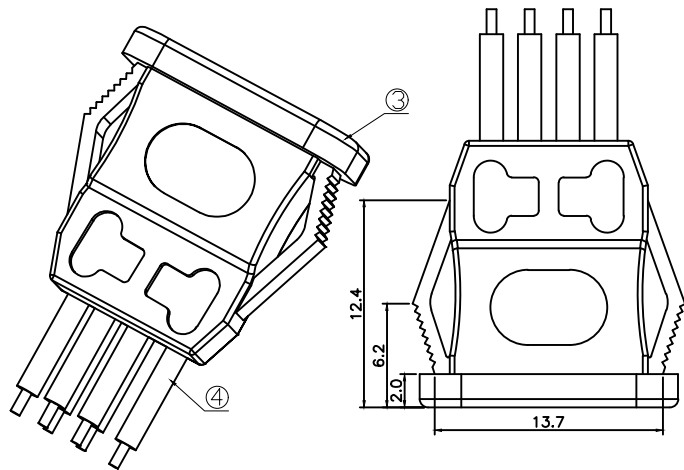

- 技术要求
1. 插入力: 5-20N(0.5-2.0kgf)
 2. 拔出力: 8-20N(0.8-2.0kgf)
 3. 接触电阻: 40mΩ MAX
 4. 绝缘电阻: 100MΩ MIN
 5. 耐电压: AC 250V 1min
无飞弧及击穿
 6. 寿命: 10000 10-20次/min
 7. 额定负载: DC 12V 0.5-5A
 8. 适用温度范围: -25-85° C

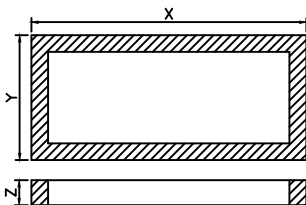
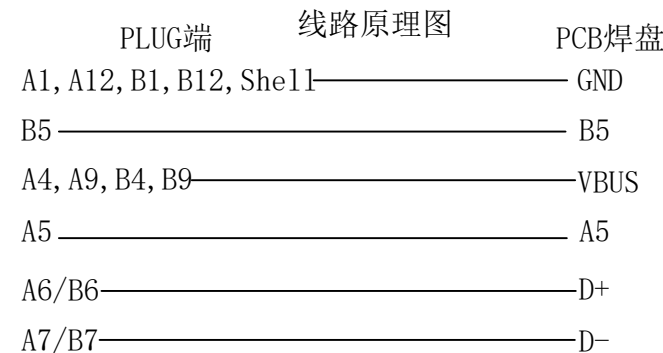
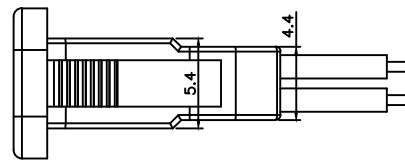
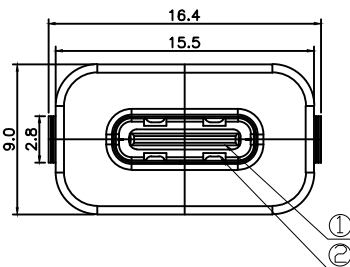
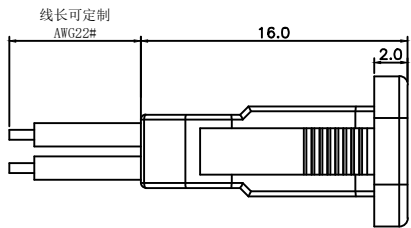

PANEL CUT-OUT		
Z	X	Y
0.8 ~ 1.5	14.2 ~ 14.4	5.5 ~ 5.7
1.5 ~ 2.5	14.4 ~ 14.6	5.5 ~ 5.7
1.5 ~ 3.0	14.6 ~ 14.8	5.5 ~ 5.7

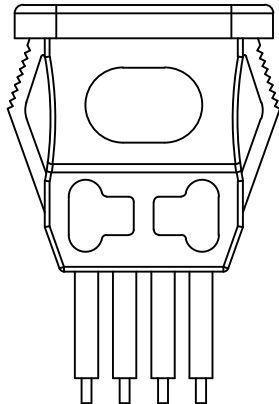

- 红色 V+
- 蓝色 D+
- 白色 D-
- 黑色 GND
- 绿色 A5
- 黄色 B5

CUSTOMER DRAWING			铭创科技(东莞)有限公司 Mingchuang Technology (Dongguan) Co., Ltd.		
UNITS mm	SCALE 1:1	SHEET 1 OF 2	TITLE 防水TYPE-C母座 六芯线 L=16.0 带耳		
PROJECTION: 	DRAW: DAP	CHECK: HWT	MAT'L SEE TABLE	FINISH SEE TABLE	
GENERAL TOLERANCE 0. ±0.35 0.0 ±0.25 0.00 ±0.15 0.° ±4° 0.0° ±3°		APPD: HHM	DWG. NO. A010601A	PART NO. _____	SIZE A4